

SK20 MACHINECARD

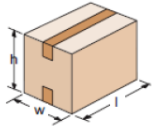

DATE
CUSTOMER

SK20



SK20 : Semi-Automatic Fix Size Cartons Sealing Machine

Standard

Taping Head K11/70	L	W	H
Min.	150	140	120
Max.	∞	500	500

Taping Head K11/50	L	W	H
Min.	150	140	100
Max.	∞	500	500

Optional Taping Head K11/30	L	W	H
Min.	150	140	90
Max.	∞	500	500

Configurable On Demand

Taping Head K12/70	L	W	H
Min.	150	170	120
Max.	∞	500	500

Taping Head K12/50	L	W	H
Min.	150	170	100
Max.	∞	500	500

Capacity Production :

up to 1200 Bph

Always based on shorter box manageable.

Any different dimension out of the standards above will be on request.

Standard Voltage	Amps	Power kW	Phase
380/400V - 50HZ - 3F	1,08	0,26	3Ph + N + PE
440V - 60HZ - 3F			

Other Voltages on request

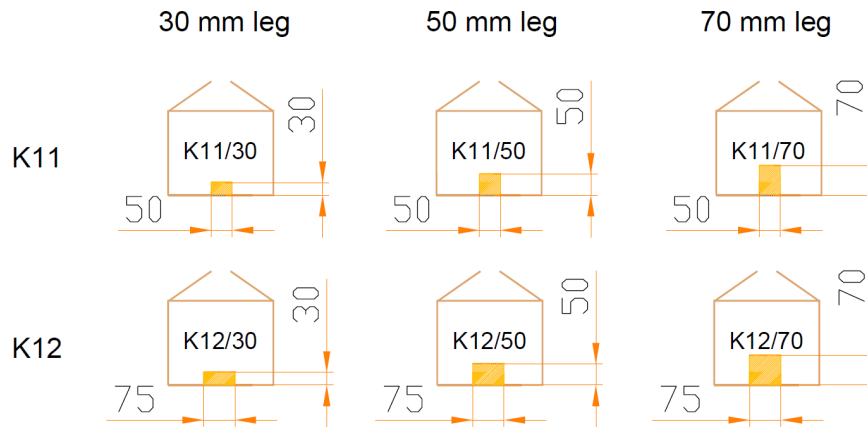

TAPING UNIT POSITION

TOP + BOTTOM

TOP ONLY + BOTTOM PLATE

BOTTOM

MACHINE WORKING SIDE

LEFT SIDE

RIGHT SIDE

LEFT MACHINE

RIGHT MACHINE

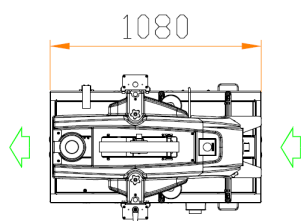

command side

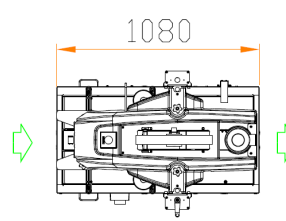

command side

WORKBENCH HEIGHT

FROM 485 UP TO 825 mm

FROM 645 UP TO 980 mm

SPECIAL REQUEST FOR WORKBENCH HEIGHT

MACHINE ON WHEELS

YES if yes please consider + 110 mm on workbench height
NO

POWER SUPPLY 380/415V 50Hz 3PH + N + PE

OTHER REQUEST , PLEASE SPECIFY

MACHINE COLORS STANDARD (as per photo)



ENVIRONMENT CONDITIONS (inside the company building)

- ALTITUDE (LESS THAN 1000 M A.S.L.)
- HIGH TEMPERATURE (NOT MORE THAN 40 °C)
- LOW TEMPERATURE (NOT LESS THAN 5°C)
- HIGH HUMIDITY (NOT MORE THAN 80%)

ACCESSORIES

ENERGY SAVING DEVICE
(no need of PLC)

MACHINE LAYOUT

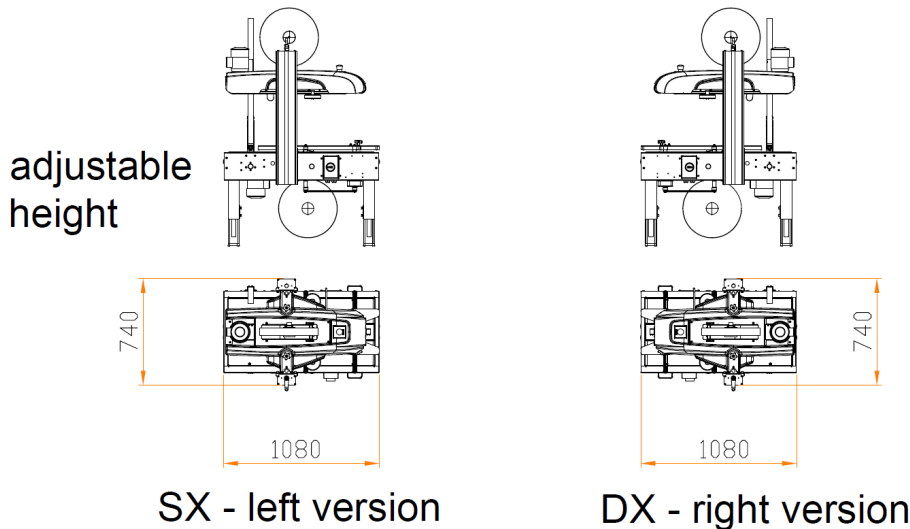

BOXES INFORMATION: Note. standard weight range is 2- 30 kg, supposed for a product full box. Any other difference from these values should be evaluated by engineering department. In the last page the customer can check the general features required for the box.

	FEFCO TYPE	LENGTH (mm)	WIDTH (mm)	HEIGHT (mm)	WEIGHT (kg)	OUTPUT (BPM)
BOX 1						
BOX 2						
BOX 3						
BOX 4						
BOX 5						
BOX 6						
BOX 7						
BOX 8						
BOX 9						
BOX 10						

WILL THE CUSTOMER SUPPLY BOXES TO BE TESTED? YES NO

IF YES PLEASE SEND SAMPLES TO:
SIAT S.P.A. via Puecher, 22 TURATE (CO) ITALY TO THE ATTENTION OF FLAVIO PUGLIESE, AT LEAST TWO WEEKS BEFORE THE ESTIMATED DELIVERY DATE

IF YES, HOW MANY TYPES OF BOX DOES THE CUSTOMER WANT TO TEST?

3 TYPES - MAX 60 PIECES, TESTED FREE OF CHARGE

FROM 4 TO 10 TYPES - MAX 100 TOTAL PIECES, UNDER PAYMENT

> 60 PIECES , UNDER PAYMENT





WILL THE CUSTOMER DO THE F.A.T. FOR THIS MACHINE?
(under payment - with a max of 10 different boxes test) YES NO

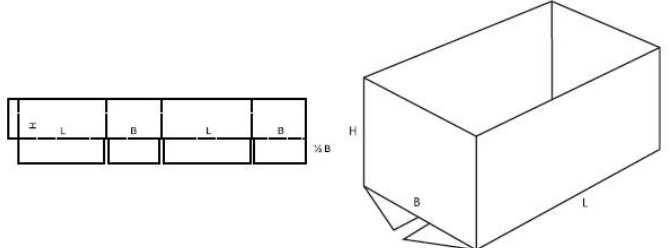
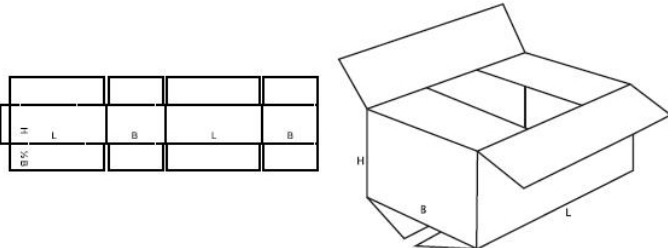

WILL SIAT INSTALL THE MACHINE?
(under payment) YES NO

SPECIAL REQUESTS (if needed)

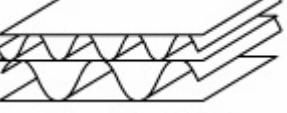
CARTON TYPE

FEFCO BOX TYPE

BOX MODEL	0200 M/A	
	0201 M/A	
CARDBOARD TYPE LAYERS STYLE	SINGLE FLUTE	
	TWO LAYERS + SINGLE FLUTE	
	THREE LAYERS + DOUBLE FLUTE	
	FOUR LAYERS + TRIPLE FLUTE	

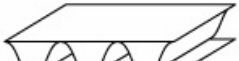
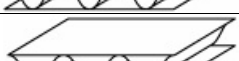
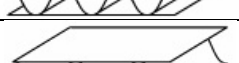
CARDBOARD TYPE FLUTE STYLE	FLUTE "F"	
	FLUTE "E"	
	FLUTE "C"	
	FLUTE "B"	
	FLUTE "A"	

FEFCO BOX TYPE

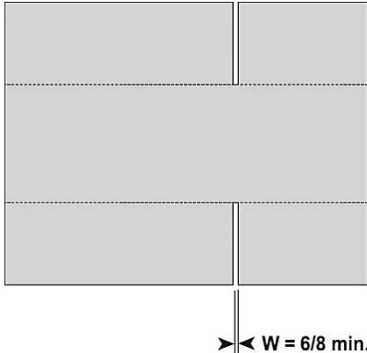
MINIMUM BOXES REQUIREMENTS	<ol style="list-style-type: none"> 1. GOOD TEXTURE OF CARTONS WITH SIDE FREE OF FOLDS 2. CREASE LINE WELL MARKED. PREFERABLY DOUBLE. 3. WHEN THE BOX IS CLOSED, FLAPS MUST NOT TOUCH THEMSELVES. MIN. 2 mm OF SPACE NEEDED. 4. MIN. WIDTH OF CUTS: 6 – 8 mm (see picture) 5. PLEASE ADVISE IN CASE OF USE OF SQUARE BOXES 6. PLEASE ADVISE IN CASE OF SPECIAL PROCESSING OF CARDBOARD (ex. die-cutting) 7. PLEASE ADVISE THE FEFCO BOX TYPE ACCORDING TO THE ABOVE CODIFICATION 	 <p style="text-align: right;">W = 6/8 min.</p>
-----------------------------------	--	---

TAPING UNIT PERFORMANCE

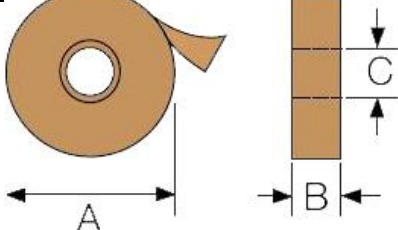
TAPE REEL DIMENSIONS	A	MAX. 410 mm	
	B	75 mm / 50 mm	
	C	76 mm	

TAPE LEG

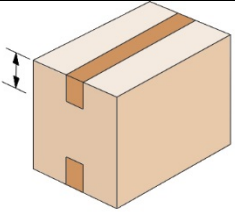
TAPE LEG DIMENSIONS	K11R / K12R	70 mm	
	K11R / K12R	50 mm	
	K11/30 K12/30	30 mm	